

LAB COCK

FEATURES

The LAB COCK is a compact, light weight plastic valve which is highly corrosion-resistant, in durable.

NSF Product

NSF("NSF/ANSI STANDARD 61" Drinking Water System Components-Health Effects)Product.

:LAB COCK(Material:PVC+EPDM)

*Certified products bear an NSF Certification Mark.

MATERIAL AND WORKING TEMPERATURE

Body material	Unplasticized Polyvinyl Chloride(PVC)
Working Temperature	0°C - 50°C (30° F - 120° F)
Max.Working Pressure	1.0MPa{10.2kgf/cm ² }[150PSI]
End Connectors	Hose, Male thread, Female thread
Nominal Size	●Hose: 12 to 15mm(standard hose inner diameter) ●Male thread: 1/4, 1/2 ●Female thread: 1/4, 3/8

WORKING PRESSURE VS. TEMPERATURE

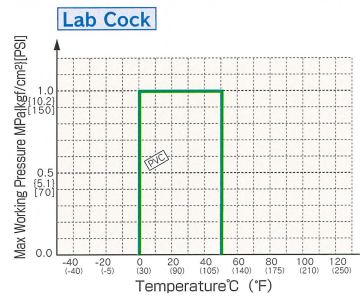

DIMENSION

FEMALE THREAD × FEMALE THREAD

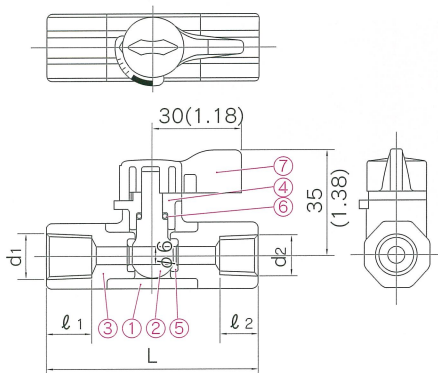

HOSE × HOSE

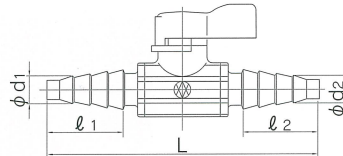

MALE THREAD × HOSE

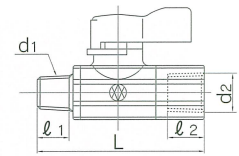
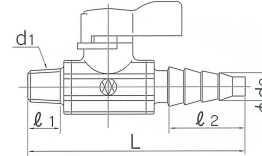

FEMALE THREAD × HOSE

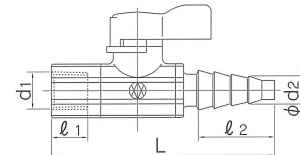

MALE THREAD × MALE THREAD

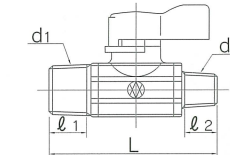

PARTS & MATERIALS

No.	DESCRIPTION	Pcs.	MATERIAL
①	BODY	1	PVC
②	BALL & STEM	1	PVC
③	END CONNECTOR	2	PVC
④	GLAND	1	PVC
⑤	SEAT	2	EPDM, PTFE, others
⑥	O-RING	1	EPDM, others
⑦	HANDLE	1	ABS

DIMENSIONS TABLE

JIS											Unit:mm
	d ₁	d ₂	l ₁	l ₂	L		d ₁	d ₂	l ₁	l ₂	L
FEMALE THREAD × FEMALE THREAD	Rc 1/4	Rc 1/4	15	15	71	MALE THREAD × HOSE	R 1/4	10	13	30.5	88.5
	Rc 3/8	Rc 1/4	15	15	71		R 1/2	10	15	30.5	91
	Rc 3/8	Rc 3/8	15	15	71		R 1/4	R 1/4	13	13	66
HOSE × HOSE	10	10	30.5	30.5	111	MALE THREAD × MALE THREAD	R 1/2	R 1/4	15	13	68.5
FEMALE THREAD × HOSE	Rc 1/4	10	15	30.5	91		R 1/2	R 1/2	15	15	71
	Rc 3/8	10	15	30.5	91	R 1/4	Rc 1/4	13	15	68.5	
MALE THREAD × FEMALE THREAD	R 1/4	Rc 3/8	13	15	68.5		R 1/4	Rc 3/8	13	15	68.5
	R 1/2	Rc 1/4	15	15	71		R 1/2	Rc 1/4	15	15	71
	R 1/2	Rc 3/8	15	15	71		R 1/2	Rc 3/8	15	15	71

DIN							Unit:mm						
		d ₁	d ₂	ℓ ₁	ℓ ₂	L			d ₁	d ₂	ℓ ₁	ℓ ₂	L
①	FEMALE THREAD × FEMALE THREAD	Rp 1/4	Rp 1/4	15	15	71	④	MALE THREAD × HOSE	R 1/4	10	13	30.5	88.5
		Rp 3/8	Rp 1/4	15	15	71			R 1/2	10	15	30.5	91
		Rp 3/8	Rp 3/8	15	15	71							
②	HOSE × HOSE	10	10	30.5	30.5	111	⑤	MALE THREAD × MALE THREAD	R 1/4	R 1/4	13	13	66
③	FEMALE THREAD × HOSE	Rp 1/4	10	15	30.5	91			R 1/2	R 1/4	15	13	68.5
		Rp 3/8	10	15	30.5	91			R 1/2	R 1/2	15	15	71
⑥	MALE THREAD × FEMALE THREAD	R 1/4	Rp 1/4	13	15	68.5	R 1/4	Rp 1/4	13	15	68.5		
		R 1/4	Rp 3/8	13	15	68.5	R 1/4	Rp 3/8	13	15	68.5		
		R 1/2	Rp 1/4	15	15	71	R 1/2	Rp 1/4	15	15	71		
		R 1/2	Rp 3/8	15	15	71	R 1/2	Rp 3/8	15	15	71		

ANSI							Unit:inch						
		d ₁	d ₂	ℓ ₁	ℓ ₂	L			d ₁	d ₂	ℓ ₁	ℓ ₂	L
①	FEMALE THREAD × FEMALE THREAD	1/4-18NPT	1/4-18NPT	0.51	0.51	2.80	④	MALE THREAD × HOSE	1/4-18NPT	0.39	0.51	1.20	3.48
		3/8-18NPT	1/4-18NPT	0.59	0.51	2.80			1/2-14NPT	0.39	0.59	1.20	3.58
		3/8-18NPT	3/8-18NPT	0.59	0.59	2.80							
②	HOSE × HOSE	0.39	0.39	1.20	1.20	4.37	⑤	MALE THREAD × MALE THREAD	1/4-18NPT	1/4-18NPT	0.51	0.51	2.60
③	FEMALE THREAD × HOSE	1/4-18NPT	0.39	0.51	1.20	3.58			1/2-14NPT	1/4-18NPT	0.59	0.51	2.70
		3/8-18NPT	0.39	0.59	1.20	3.58			1/2-14NPT	1/2-14NPT	0.59	0.59	2.80
⑥	MALE THREAD × FEMALE THREAD	1/4-18NPT	1/4-18NPT	0.51	0.51	2.70	1/4-18NPT	1/4-18NPT	0.51	0.51	2.70		
		1/4-18NPT	3/8-18NPT	0.51	0.59	2.70	1/4-18NPT	3/8-18NPT	0.51	0.59	2.70		
		1/2-14NPT	1/4-18NPT	0.59	0.51	2.80	1/2-14NPT	1/4-18NPT	0.59	0.51	2.80		
		1/2-14NPT	3/8-18NPT	0.59	0.59	2.80	1/2-14NPT	3/8-18NPT	0.59	0.59	2.80		
⑦	MALE THREAD × ELBOW	1/2-14NPT	0.63	0.59	1.26	3.66							

■ LAB COCK 1/2inch MALE THREAD × ELBOW16mm

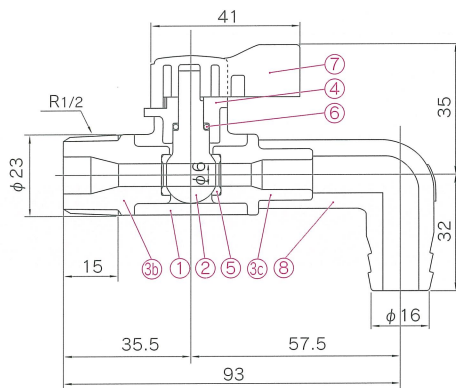

MATERIAL AND WORKING TEMPERATURE

Body material	Unplasticized Polyvinyl Chloride(PVC)
Working Temperature	0°C - 50°C (30° F - 120° F)
Max. Working Pressure	1.0MPa{10.2kgf/cm ² }[150PSI]
End Connectors	R1/2inch Male thread × Elbow16mm

PARTS & MATERIALS

No.	DESCRIPTION	Pcs.	MATERIAL
①	BODY	1	PVC
②	BALL & STEM	1	PVC
③a	END CONNECTOR	1	PVC
③c	END CONNECTOR	1	PVC
④	GLAND	1	PVC
⑤	SEAT	2	PTFE
⑥	O-RING	1	EPDM, Others
⑦	HANDLE	1	ABS
⑧	ELBOW	1	PVC